

SINAMICS

Variable Speed Drive for pumps and fans

G120P..



Variable speed drives for energy-optimized open-loop or closed-loop speed control to control pump and fan motors in building-related applications.

- Power range: 0.75 kW to 75 kW (IP20) / 90 kW (IP55)
- Voltage range: 3AC 380 ... 480 V
- Standard with RS485/USS, Modbus/RTU, BACnetMS/TP, P1
- Optional PROFIBUS DP, CANopen, PROFINET IO
- 4 internal PID controllers
- High degree of protection IP55/UL Type 12, and for cabinet installation IP20
- With EMC filter Class A (C2) or Class B (C1)
- Modular design of power and control electronics

Use

- Demand-controlled speed control of supply and discharge fans in air conditioning systems
- Demand-controlled speed control of circulating pumps in HVAC systems
- Pressure boost and control of the fill level of pumps

Functions

Functions specific to pumps and fans are already integrated

- Automatic restart
Application restarts after a power failure or a fault
- Flying restart
Variable speed drive is switched in while the motor is running
- ECO mode
Automatic adaptation of the motor current to the actual load conditions, e.g. for applications with a low dynamic response and a constant speed setpoint
- Motor staging
For applications that require simultaneous operation of between 1 and 4 motors depending on load, e.g. closed-loop control of highly fluctuating flow volumes
- Hibernation: Drive is started/stopped in accordance with the actual setpoints
- 4 integrated PID controllers
For controlling the speed of the drive as a function of pressure, temperature, flowrate, level, air quality and other process variables
- Essential Service Mode
Special operating mode of the variable speed drive that enhances the availability of the drive system in the event of a fire
- Multi-zone controller
 - Control of a zone with up to 3 sensors for pressure or temperature, or
 - Control of two independent zones, each with one sensor
- Bypass mode
When the setpoint is reached or a fault occurs, there is a changeover to mains operation
- Programmable time switches (x 3 units)
- Real-time clock
For time-dependent process controls, e.g. temperature reduction for heating control at night
- Freely programmable logical function blocks
For simulating simple PLC functions
- Motor monitoring with and without temperature sensor (via PTC, KTY and ThermoClick sensor)
 - Overcurrent protection
 - Torque monitoring
 - Overvoltage protection (Vdc_max controller)
- Braking function using a DC brake

Connections and interfaces

- Fieldbus interface of the CU230P-2 Control Unit optionally with
 - RS485/USS, Modbus/RTU, BACnetMS/TP, P1 (standard delivery)
 - PROFIBUS DP
 - CANopen
 - PROFINET IO
- 2 x LG-Ni1000-/Pt1000 interface for direct connection of temperature sensors
- 230 V relay for direct connection of auxiliary equipment
- Isolated digital inputs with a separate potential group to prevent potential transfers

- Isolated analog inputs for EMC-compliant installation without the need for additional components

Energy efficiency

- Optimized drive topology
 - Limit values for harmonic currents and THD compliant with IEC/EN 61000-3-12 are fulfilled without the need for additional measures ($R_{sce} \geq 120$)
 - Reduced line harmonics
 - No reactors → lower weight & smaller installation space requirements
 - Lower apparent power → smaller cable cross-sections
- Implemented energy-saving functions

User-friendliness

The following functions and resources ensure a high degree of user-friendliness:

- Simple application-specific commissioning wizards "on board" the IOP-2 operator panel (Intelligent Operator Panel)
- Clear text scripts for integration in the STARTER commissioning tool for more complex applications
- Operator panel with clear text display and extensive diagnostics functions (IOP-2)
- SINAMICS micro memory card (MMC)/SIMATIC memory card (SD card) for storing parameter settings, cloning and local commissioning
- Plug-in terminal blocks for supply cables and motor cables for frame sizes A to C

Desigo connection

G120P is compatible with Desigo systems from Version 4.1, and can be integrated via Modbus and USS.

Software

A license to use the STARTER commissioning software is included in the G120P BT bundle. You can find the latest version at www.siemens.com/starter.

STARTER is also included in the SINAMICS G120P PC inverter connection KIT 2 as an accessory or can be ordered separately. See Accessories.

Technical design

Components





SINAMICS G120P is a combination of SINAMICS Control Unit CU230P-2 BT with the SINAMICS Power Module PM230 that is harmonized and coordinated for pump and fan applications, as well as an operator panel or a blanking cover. The operator panel or blanking cover is not included in the scope of supply and must be separately ordered.

The following versions of CU230P-2 are available:

- CU230P-2 BT with RS485 interface for USS, Modbus RTU, BACnetMS/TP and P1. This is included in the standard scope of supply of the G120P bundle.
- CU230P-2 CAN with CANopen interface. Optionally order.
- CU230P-2 DP with PROFIBUS DP interface. Optionally order.
- CU230P-2 PN with PROFINET IO interface. Optionally order.

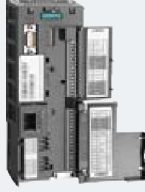
The PM230 Power Module is available in the following versions:

- IP55 with integrated EMC filter A (C2) or integrated EMC filter B (C1)
- IP20 with integrated EMC filter A (C2) or unfiltered with external EMC filter B (C1)
- IP20 with integrated filter A or unfiltered in a push-through design (not available as bundle, this must be ordered separately.)

G120P Bundle		order separately
Control Unit CU230P-2 BT incl. shield connection kit 	Power Module PM230 3 AC 380 ... 480 V 0.75 ... 75 kW (IP20) 0.75 ... 90 kW (IP55) 	Operator panel IOP-2 Intelligent Operator Panel  or BOP-2 Basic Operator Panel  or Blanking cover 
Optional accessory Memory cards PC inverter connection kit 2 CU230P-2 DP (PROFIBUS DP) CU230P-2 CAN (CANopen) CU230P-2 PN (PROFINET IO)		Spare parts Small mounting parts Fan units



A screening termination kit for the PM230 Power Module is included with the IP20 devices in frame sizes A to C. For frame sizes D to F, the screening termination kit must be ordered separately if required.

Options

Rear panels for mounting IP55, frame sizes FSA-FSC

To ensure the cooling capacity, IP55 devices in frame sizes FSA to FSC must be mounted directly onto a flat wall. If this is not possible, for example in the case of a suspended installation on a busbar system, an air guide sheet (available separately) must be attached.

This is cut to size and comes with the corresponding holes so it can be screwed directly onto the rear of the Power Module.

You can find ordering information in the type summary.

Installation sets for IP55 devices

An appropriate installation set can be ordered for every frame size from FSA to FSF. This allows you to ensure that all necessary installation material for correct cabling is available.

The sets comprise polyamide cable glands with separate rubber seals for a larger terminal area for the power supply and control cables, as well as a high-quality EMC cable gland for the motor cable, which enables the shield to be fed into the enclosure. This is required in order to comply with the EMC C1 standard.

The sets include cable lugs for attaching the equipotential bonding and end sleeves/cable lugs (FSD and up) for the motor and power supply cable.

The sets comprise the following components:

	FSA	FSB	FSC	FSD	FSE	FSF
Brass EMC cable gland for motor cables incl. EMC lock nuts	1 unit M20x1.5	1 unit M25x1.5	1 unit M32x1.5	1 unit M40x1.5	1 unit M50x1.5	1 unit M63x1.5
Polyamide cable gland for power supply cable incl. lock nuts	1 unit M20x1.5 Terminal area 5-12 mm	1 unit M25x1.5 Terminal area 8-17 mm	1 unit M32x1.5 Terminal area 11-21 mm	1 unit M40x1.5 Terminal area 16-28 mm	1 unit M50x1.5 Terminal area 21-38 mm	1 unit M63x1.5 Terminal area 27-44 mm
Polyamide cable gland for control cables incl. lock nuts	3 units M20x1.5 Terminal area 5-12 mm	3 units M20x1.5 Terminal area 5-12 mm	3 units M20x1.5 Terminal area 5-12 mm	4 units M20x1.5 Terminal area 5-12 mm	4 units M20x1.5 Terminal area 5-12 mm	4 units M20x1.5 Terminal area 5-12 mm

	FSA	FSB	FSC	FSD	FSE	FSF
Cable lug for equipotential bonding	1 unit Ø 10 mm ² 1 unit Ø16 mm ²	1 unit Ø 10 mm ² 1 unit Ø16 mm ²	1 unit Ø 10 mm ² 1 unit Ø16 mm ²	1 unit Ø16 mm ²	1 unit Ø16 mm ²	1 unit Ø16 mm ²
End sleeves for power supply & motor cables in accordance with DIN 46228 T 1	8 units Ø1 mm ² 8 units Ø1.5 mm ² 8 units Ø2.5 mm ²	8 units Ø2.5 mm ² 8 units Ø4 mm ² 8 units Ø6 mm ²	8 units Ø6 mm ² 8 units Ø10 mm ² 8 units Ø16 mm ²	/	/	/
Cable lugs for power supply & motor cables	/	/	/	8 units Ø10 mm ² 8 units Ø16 mm ² 8 units Ø25 mm ² 8 units Ø35 mm ²	8 units Ø25 mm ² 8 units Ø35 mm ² 8 units Ø50 mm ² 8 units Ø16 mm ²	8 units Ø70 mm ² 8 units Ø95 mm ² 8 units Ø120 mm ²



The fourth generation EMC cable gland facilitates cable entry on both sides as well as good radial and axial alignment of the cable without damaging the braiding.

Dimension drawing	Size	TL (mm)	Clamping range min/max (mm)	Shield diameter min/max (mm)	H (mm)	SW 1 (mm)	SW 2 (mm)
	M20 x 1.5	8.0	7.5 - 14	5.5 - 11.5	38	24	24
	M25 x 1.5	8.0	10 - 18	7 - 14	42	30	30
	M32 x 1.5	9.0	16 - 25	12 - 20	50	40	40
	M40 x 1.5	9.0	22 - 32	18 - 27	57	50	50
	M50 x 1.5	9.0	30 - 38	26 - 34	67	58	60
	M63 x 1.5	10.0	37 - 53	33 - 49	72	75	75

Type summary

IP55 bundle

Filter A

Order no./MLFB	Type	Output current (A)	Efficiency η	Frame size	Power (kW)
6SL3200-6AM12-2AH0	G120P-0.75/35A	2.2	0.92	A	0.75
6SL3200-6AM13-1AH0	G120P-1.1/35A	3.1	0.94	A	1.1
6SL3200-6AM14-1AH0	G120P-1.5/35A	4.1	0.95	A	1.5
6SL3200-6AM15-8AH0	G120P-2.2/35A	5.9	0.96	A	2.2
6SL3200-6AM17-7AH0	G120P-3/35A	7.7	0.96	A	3
6SL3200-6AM21-0AH0	G120P-4/35A	10.2	0.97	B	4
6SL3200-6AM21-3AH0	G120P-5.5/35A	13.2	0.97	B	5.5
6SL3200-6AM21-8AH0	G120P-7.5/35A	18	0.97	B	7.5
6SL3200-6AM22-6AH0	G120P-11/35A	26	0.97	C	11
6SL3200-6AM23-2AH0	G120P-15/35A	32	0.97	C	15
6SL3200-6AM23-8AH0	G120P-18.5/35A	38	0.98	C	18.5
6SL3200-6AM24-5AH0	G120P-22/35A	45	0.97	D	22
6SL3200-6AM26-0AH0	G120P-30/35A	60	0.97	D	30

Order no./MLFB	Type	Output current (A)	Efficiency η	Frame size	Power (kW)
6SL3200-6AM27-5AH0	G120P-37/35A	75	0.97	E	37
6SL3200-6AM28-8AH0	G120P-45/35A	90	0.97	E	45
6SL3200-6AM31-1AH0	G120P-55/35A	110	0.97	F	55
6SL3200-6AM31-4AH0	G120P-75/35A	145	0.97	F	75
6SL3200-6AM31-7AH0	G120P-90/35A	178	0.97	F	90

Filter B

Order no./MLFB	Type	Output current (A)	Efficiency η	Frame size	Power (kW)
6SL3200-6AM12-2BH0	G120P-0.75/35B	2.2	0.92	A	0.75
6SL3200-6AM13-1BH0	G120P-1.1/35B	3.1	0.94	A	1.1
6SL3200-6AM14-1BH0	G120P-1.5/35B	4.1	0.95	A	1.5
6SL3200-6AM15-8BH0	G120P-2.2/35B	5.9	0.96	A	2.2
6SL3200-6AM17-7BH0	G120P-3/35B	7.7	0.96	A	3
6SL3200-6AM21-0BH0	G120P-4/35B	10.2	0.97	B	4
6SL3200-6AM21-3BH0	G120P-5.5/35B	13.2	0.97	B	5.5
6SL3200-6AM21-8BH0	G120P-7.5/35B	18	0.97	B	7.5
6SL3200-6AM22-6BH0	G120P-11/35B	26	0.97	C	11
6SL3200-6AM23-2BH0	G120P-15/35B	32	0.97	C	15
6SL3200-6AM23-8BH0	G120P-18.5/35B	38	0.98	D	18.5
6SL3200-6AM24-5BH0	G120P-22/35B	45	0.97	D	22
6SL3200-6AM26-0BH0	G120P-30/35B	60	0.97	D	30
6SL3200-6AM27-5BH0	G120P-37/35B	75	0.97	E	37
6SL3200-6AM28-8BH0	G120P-45/35B	90	0.97	E	45
6SL3200-6AM31-1BH0	G120P-55/35B	110	0.97	F	55
6SL3200-6AM31-4BH0	G120P-75/35B	145	0.97	F	75
6SL3200-6AM31-7BH0	G120P-90/35B	178	0.97	F	90

IP20 bundle

Filter A

Order no./MLFB	Type	Output current (A)	Efficiency η	Frame size	Power (kW)
6SL3200-6AE12-2AH0	G120P-0.75/32A	2.2	0.93	A	0.75
6SL3200-6AE13-1AH0	G120P-1.1/32A	3.1	0.94	A	1.1
6SL3200-6AE14-1AH0	G120P-1.5/32A	4.1	0.95	A	1.5
6SL3200-6AE15-8AH0	G120P-2.2/32A	5.9	0.96	A	2.2
6SL3200-6AE17-7AH0	G120P-3/32A	7.7	0.96	A	3
6SL3200-6AE21-0AH0	G120P-4/32A	10.2	0.97	B	4
6SL3200-6AE21-3AH0	G120P-5.5/32A	13.2	0.97	B	5.5
6SL3200-6AE21-8AH0	G120P-7.5/32A	18	0.97	B	7.5
6SL3200-6AE22-6AH0	G120P-11/32A	26	0.97	C	11
6SL3200-6AE23-2AH0	G120P-15/32A	32	0.97	C	15
6SL3200-6AE23-8AH0	G120P-18.5/32A	38	0.98	C	18.5
6SL3200-6AE24-5AH0	G120P-22/32A	45	0.98	D	22
6SL3200-6AE26-0AH0	G120P-30/32A	60	0.97	D	30
6SL3200-6AE27-5AH0	G120P-37/32A	75	0.97	E	37

Order no./MLFB	Type	Output current (A)	Efficiency η	Frame size	Power (kW)
6SL3200-6AE28-8AH0	G120P-45/32A	90	0.97	E	45
6SL3200-6AE31-1AH0	G120P-55/32A	110	0.97	F	55
6SL3200-6AE31-4AH0	G120P-75/32A	145	0.97	F	75

Filter B

Order no./MLFB	Type	Output current (A)	Efficiency η	Frame size	Power (kW)
6SL3200-6AE12-2BH0	G120P-0.75/32B	2.2	0.93	A	0.75
6SL3200-6AE13-1BH0	G120P-1.1/32B	3.1	0.94	A	1.1
6SL3200-6AE14-1BH0	G120P-1.5/32B	4.1	0.95	A	1.5
6SL3200-6AE15-8BH0	G120P-2.2/32B	5.9	0.96	A	2.2
6SL3200-6AE17-7BH0	G120P-3/32B	7.7	0.96	A	3
6SL3200-6AE21-0BH0	G120P-4/32B	10.2	0.97	B	4
6SL3200-6AE21-3BH0	G120P-5.5/32B	13.2	0.97	B	5.5
6SL3200-6AE21-8BH0	G120P-7.5/32B	18	0.97	B	7.5
6SL3200-6AE22-6BH0	G120P-11/32B	26	0.97	C	11
6SL3200-6AE23-2BH0	G120P-15/32B	32	0.97	C	15
6SL3200-6AE23-8BH0	G120P-18.5/32B	38	0.98	C	18.5
6SL3200-6AE24-5BH0	G120P-22/32B	45	0.98	D	22
6SL3200-6AE26-0BH0	G120P-30/32B	60	0.97	D	30
6SL3200-6AE27-5BH0	G120P-37/32B	75	0.97	E	37
6SL3200-6AE28-8BH0	G120P-45/32B	90	0.97	E	45
6SL3200-6AE31-1BH0	G120P-55/32B	110	0.97	F	55
6SL3200-6AE31-4BH0	G120P-75/32B	145	0.97	F	75

Accessories

Description	Order no./MLFB	Type (ASN)
SINAMICS G120P IP20 / IP55, basic operator panel (BOP-2)	6SL3255-6AA00-4CA0	G120P-BOP-2
SINAMICS G120P IP20 / IP54, intelligent operator panel (IOP-2)	6SL3255-6AA00-4JA1	G120P-IOP-2
SINAMICS G120P blanking cover for PM230 POWER MODULE, IP55/UL Type 12 degree of protection	6SL3256-6BA00-0AA0	G120P-BCover
SINAMICS G120P door mounting kit IOP-2 (IP54) / BOP-2 (IP55), KIT UL Type 12 for the intelligent operator panel IOP-2 and basic operator panel BOP-2 comprising: Seal, installation material, and connecting cable (5 m)	6SL3256-6AP00-0JA0	G120P-Door-Kit
SINAMICS G120P PC inverter connection kit 2 comprising: STARTER commissioning software on DVD and 3 m USB cable for Control Units CU230P-2	6SL3255-0AA00-2CA0	G120P-PC-Kit
SINAMICS G120P MMC parameter memory card	6SL3254-0AM00-0AA0	G120P-MMC-Card
STARTER parameterizing software for Sinamics and Micromaster drives. VERSION V4.3.2 DVD for Windows 2000 SP4, Windows Server 2003 SP2, Windows XP Prof SP3, Windows 7 Prof. (32 bit) and Windows 7 Ultimate (32 bit). English, German, French, Italian, and Spanish. Free of charge updates for customers with license, available online after purchase.	6SL3072-0AA00-0AG0	G120P Starter
TX OPEN module for Desigo integration	S55661-J100	TXI1.OPEN

Description	Order no./MLFB	Type (ASN)
Control Unit CU230P-2 DP with PROFIBUS DP. I/O: 6 DI, 3 DO, 4 AI, 2 AO, 1 motor temperature sensor input, 2 PSU-OUT (10V DC, 24V DC), 1 PSU-IN (24V DC), USB and MMC insert	6SL3243-0BB30-1PA3	CU230P-2 DP
Control Unit CU230P-2 CAN with CANOPEN. I/O: 6 DI, 3 DO, 4 AI, 2 AO, 1 motor temperature sensor input, 2 PSU-OUT (10V DC, 24V DC), 1 PSU-IN (24V DC), USB and MMC insert	6SL3243-0BB30-1CA3	CU230P-2 CAN
SINAMICS G120 Control Unit CU230P-2 PN with PROFINET IO. I/O: 6 DI, 3 DO, 4 AI, 2 AO 1 motor temperature sensor input, 2 PSU-OUT(10V DC, 24V DC), 1 PSU-IN (24V DC) USB and MMC insert	6SL3243-0BB30-1FA0	CU230P-2 PN
SINAMICS G120P PM230, IP20 screening termination kit for FSD and FSE. Contains: Screening plate and fixing accessories	6SL3262-1AD00-0DA0	G120P-Screen-FSDE
SINAMICS G120P PM230, IP20 screening termination kit for FSF. Contains: Screening plate and fixing accessories	6SL3262-1AF00-0DA0	G120P-Screen-FSF
Air guide sheet for installing the G120P (PM230) IP55, FSA in systems without direct wall mounting	6SL3266-7SA00-0MA0	G120P-AirSheet-FSA
Air guide sheet for installing the G120P (PM230) IP55, FSB in systems without direct wall mounting	6SL3266-7SB00-0MA0	G120P-AirSheet-FSB
Air guide sheet for installing the G120P (PM230) IP55, FSC in systems without direct wall mounting	6SL3266-7SC00-0MA0	G120P-AirSheet-FSC
Installation set for the G120P (PM230) IP55, FSA	6SL3266-7LA00-0MA0	G120P-Ins-Kit-FSA
Installation set for the G120P (PM230) IP55, FSB	6SL3266-7LB00-0MA0	G120P-Ins-Kit-FSB
Installation set for the G120P (PM230) IP55, FSC	6SL3266-7LC00-0MA0	G120P-Ins-Kit-FSC
Installation set for the G120P (PM230) IP55, FSD	6SL3266-7LD00-0MA0	G120P-Ins-Kit-FSD
Installation set for the G120P (PM230) IP55, FSE	6SL3266-7LE00-0MA0	G120P-Ins-Kit-FSE
Installation set for the G120P (PM230) IP55, FSF	6SL3266-7LF00-0MA0	G120P-Ins-Kit-FSF
Extension cable for G120P IP55 operator panel	6SL3256-1BA00-4HB0	G120P-IP55-Pan-Ext

Spare parts

Description	Order no./MLFB	Type (ASN)
Control Unit CU230P-2 BT with USS, MODBUS RTU, BACNET MS/TP. I/O: 6 DI, 3 DO, 4 AI, 2 AO, 1 motor temperature sensor input, 2 PSU-OUT (10 VDC, 24 VDC), 1 PSU-IN (24 VDC), USB and MMC insert.	S55529-E100	CU230P-2-BT
SINAMICS G120P CU screening termination kit 1 contains: Screening plate and fixing accessories for the CONTROL UNIT CU230P-2	6SL3264-1EA00-0FA0	G120P-CUScreen
SINAMICS G120P PM230, IP20 screening termination kit for FSA. Contains: Screening plate and fixing accessories	6SL3266-1EA00-0KA0	G120P-Screen-FSA
SINAMICS G120P PM230, IP20 screening termination kit for FSB. Contains: Screening plate and fixing accessories	6SL3266-1EB00-0KA0	G120P-Screen-FSB
SINAMICS G120P PM230, IP20 screening termination kit for FSC. Contains: Screening plate and fixing accessories	6SL3266-1EC00-0KA0	G120P-Screen-FSC
SINAMICS G120P mounting set for the POWER MODULE PM230 IP55/UL Type 12 FSA G120P	6SL3200-0SK02-0AA0	G120P-MSetFSA-IP55
SINAMICS G120P mounting set for the POWER MODULE PM230 IP55/UL Type12 FSB G120P	6SL3200-0SK03-0AA0	G120P-MSetFSB-IP55
SINAMICS G120P mounting set for the POWER MODULE PM230 IP55/UL Type12 FSC G120P	6SL3200-0SK04-0AA0	G120P-MSetFSC-IP55
SINAMICS G120P mounting set for the POWER MODULE	6SL3200-0SK05-0AA0	G120P-MSetFSD-IP55

Description	Order no./MLFB	Type (ASN)
PM230 IP55/UL Type12 FSD G120P		
SINAMICS G120P mounting set for the POWER MODULE PM230 IP55/UL Type12 FSE G120P	6SL3200-0SK06-0AA0	G120P-MSetFSE-IP55
SINAMICS G120P mounting set for the POWER MODULE PM230 IP55/UL Type12 FSF G120P	6SL3200-0SK07-0AA0	G120P-MSetFSF-IP55
External fan unit for PM230 IP20 FSA and PM2x0-2 push-through FSA	6SL3200-0SF21-0AA0	G120P-FExtFSA-IP20
External fan unit for PM230 IP20 FSB and PM2x0-2 push-through FSB	6SL3200-0SF22-0AA0	G120P-FExtFSB-IP20
External fan unit for PM230 IP20 FSC and PM2x0-2 push-through FSC	6SL3200-0SF23-0AA0	G120P-FExtFSC-IP20
External fan unit for PM230, IP55/UL Type 12 FSA	6SL3200-0SF21-0AA1	G120P-FExtFSA-IP55
External fan unit for PM230, IP55/UL Type 12 FSB	6SL3200-0SF22-0AA1	G120P-FExtFSB-IP55
External fan unit for PM230, IP55/UL Type 12 FSC	6SL3200-0SF23-0AA1	G120P-FExtFSC-IP55
External fan unit for PM230, IP20 FSD and FSE	6SL3200-0SF05-0AA0	G120P-FExtFSDE-IP20
External fan unit for PM230, IP20 FSF	6SL3200-0SF08-0AA0	G120P-FExtFSF-IP20
Internal fan unit for PM230 IP55/UL Type 12 FSA, FSB, and FSC	6SL3200-0SF31-0AA0	G120P-FIntFSAC-IP55
External fan unit for PM230, IP55/UL Type 12 FSD and FSE	6SL3200-0SF24-0AA0	G120P-FExtFSDE-IP55
External fan unit for PM230, IP55/UL Type 12 FSF	6SL3200-0SF26-0AA0	G120P-FExtFSF-IP55
Internal fan unit for PM230 IP55/UL Type 12 FSD, FSE, and FSF	6SL3200-0SF32-0AA0	G120P-FIntFSDF-IP55

Product documentation

Title	Description	Source/Document ID
Mounting / commissioning	Design, installation, commissioning and troubleshooting the SINAMICS G120P.	CM2G5111en
Getting Started Guide Power Module PM230 Hardware IP55	Quick guide with dimensions and design and installation notes.	A5E02923634A
Getting Started Guide Power Module PM230 Hardware IP20	Quick guide with dimensions and design and installation notes.	A5E03460238A
Hardware Installation Manual Power Module PM230 Hardware IP55	Guide with all the information needed to install, mount, connect, and service SINAMICS G120P systems.	A5E02923635A AB
Hardware Installation Manual Power Module PM230 Hardware IP20	Guide with all the information needed to install, mount, connect, and service SINAMICS G120P systems.	A5E03448282B AA
Application examples	See link for application examples and information on use of variable speed drives	http://support.automation.siemens.com/W/view/en/20208582/136000
General product information	See link for detailed information and support tools for the variable speed drives	http://www.siemens.com/g120p
Operating Instructions Control Unit	Guide for installation engineers, commissioners, and operators on Control Unit CU230P-2	A5E34257946B AA
Function Manual, Fieldbus systems	Instructions for operation when connected to a fieldbus system	A5E34229197B AA
List Manual Control Unit	Manual with list information including parameters and error codes.	A5E33838102B AA
Desigo	Information on commissioning and integrating into Desigo systems including parameter settings	CM110576

Title	Description	Source/Document ID
PICS	SINAMICS BACnet Protocol Implementation Conformance Statement	CM2Y5111
Data sheet: Supplementary system components	Data sheet with general information on the IOP and BOP-2 devices and the blanking cover	CM1N5116en
SINAMICS G120P operation in the event of a fire	Use of Essential Service Mode (ESM)	Entry ID: 63969509
Bundle sheet	Installation instructions FSA FSF	A5E32294594A index AB
Line filters	Installation instructions FSA FSC	A5E03879697A AB
Line filters	Installation instructions FSD FSF	A5E31327192A AB

Notes

Engineering

SIZER software supports users with its comprehensive physical and technical background knowledge.

www.siemens.com/sizer

Installation

- Use without a control cabinet, i.e. wall mounting
 - IP55 when a blanking cover or a BOP-2 is used
 - IP54 when an IOP-2 is used
 - Use outdoors is not permissible
- IP20 when used in the control cabinet

Commissioning

The following resources facilitate fast commissioning without requiring expert knowledge:

- STARTER software tool with graphic screen forms for standard applications
www.siemens.com/starter
- Application-specific wizards (IOP-2)
- User-defined parameter list with a reduced number of self-selected parameters
- Simple local commissioning using the handheld version
- Series commissioning using the clone function with IOP-2 or MMC card
- Commissioning without documentation using the integrated help function (IOP-2)

Operation

The Control Unit is equipped with two LEDs, i.e. RDY (Ready) and BF (Bus Fault) which indicate the drive status by showing a red or green steady or flashing light.

Maintenance

SINAMICS G120P variable speed drives are designed to allow replacement of the Power Module where necessary without recommissioning the drive under certain conditions. As a result of the modular design, only the defective individual component has to be replaced in the event of repairs.

The SINAMICS G120P is maintenance friendly. The fans must be checked and, where relevant, replaced approximately every 40,000 operating hours.

Functional data

Electrical data	
Power (low overload LO)	0.75 to 90 kW
Line voltage	380 to 480 V 3 AC ±10 %
Line frequency	47 to 63 Hz
Overload capability of frame sizes A – C (low overload LO)	<ul style="list-style-type: none"> ● 1.5 x base-load current (150 %) for 3 s every 300 s ● 1.1 x base-load current (110%) for 57 s every 300 s
Overload capability of frame sizes D – F (low overload LO)	1.1 x base-load current (110%) for 60 s every 300 s
Rated input current (LO: at 40 °C)	2.3 to 166 A (IP55) 2.3 to 135 A (IP20)
Base-load current (LO: at 40 °C)	2.2 to 178 A (IP55) 2.2 to 145 A (IP20)
Operating temperature	0 to 60 °C while derating (see derating factors)
Relative humidity	< 95% RH, non-condensing
Output frequency	0 to 550 Hz
Pulse frequency	4 kHz (default) to 16 kHz. The pulse frequency can be changed manually in 2 kHz steps.
Frequency range that can be skipped	4, parameterizable
Fixed frequencies	15, parameterizable
Digital inputs and outputs	<ul style="list-style-type: none"> ● 6 DI ● 3 DO (2 x 230 V AC / 2 A, 1 x 30 V DC / 0.5 A) ● 4 AI (2 x 0 to 10 V / -10 to 10 V / 0 to 20 mA / 4 to 20 mA, 1 x 0 to 20 mA / 4 to 20 mA / Pt1000 / LG-Ni1000, 1 x Pt1000 / LG-Ni1000) ● 2 AO (0 to 10 V / 0 to 20 mA / 4 to 20 mA) ● 1 x KTY/PTC/ThermoClick sensor ● 2 x PSU-out (10 VDC, 24 VDC) ● 1 x PSU-in (24 VDC)
Short-circuit current rating (SCCR)	IP55 FSA - FSC: 40kA IP55 FSD - FSF: 65kA IP20 FSA - FSF: 65kA

Mechanical data	
Vibratory load	
<ul style="list-style-type: none"> ● Transport (in transport packaging) according to EN 60721-3-2 ● Operation 	Class 2M3
Test values according to EN 60068-2-6	Class 3M2
Shock stressing	
<ul style="list-style-type: none"> ● Transport (in transport packaging) according to EN 60721-3-2 ● All devices and components 	Class 2M3
<ul style="list-style-type: none"> ● Operation 	Class 3M2
Test values according to EN 60068-2-6	
Frame sizes A to F	

Environmental conditions	
Protection class according to EN 61800-5-1	Class I (with protective conductor system) and Class III (PELV)
Touch protection according to EN 61800-5-1	If used as intended
Permissible ambient and coolant temperature (air) during operation for line-side power components and Power Modules <ul style="list-style-type: none"> ● Low overload (low overload LO) ● High overload (high overload HO) 	See derating factors for derating 0 to 40 °C (32 to 104 °F) without derating > 40 to 60 °C (104 to 160 °F) with derating 0 to 50 °C (32 to 122 °F) without derating > 50 to 60 °C (122 to 160 °F) with derating
Permissible ambient and coolant temperature (air) during operation for Control Units and supplementary system components	<ul style="list-style-type: none"> ● With CU230P-2: 0 to 60 °C (32 to 140 °F) ● With IOP-2: 0 to 50 °C (32 to 122 °F) ● With BOP-2: 0 to 50 °C (32 to 122 °F) ● With blanking cover: 0 to 60 °C (32 to 140 °F) ● Up to 2000 m above sea level
Climatic ambient conditions <ul style="list-style-type: none"> ● Storage (in transport packaging) according to EN 60721-3-1 ● Transport (in transport packaging) according to EN 60721-3-2 ● Operation acc. to EN 60721-3-3 	Class 1K3 Temperature -25 to 55 °C (-13 to 131 °F) Class 2K4 Temperature -40 to 70 °C (104 to 158 °F), max. humidity 95 % at 40 °C (104 °F) Class 3K3 Condensation, splashwater, and ice formation not permitted (EN 60204, Part 1)
Environmental class/harmful chemical substances: <ul style="list-style-type: none"> ● Storage (in transport packaging) according to EN 60721-3-1 ● Transport (in transport packaging) according to EN 60721-3-2 ● Operation acc. to EN 60721-3-3 	Class 1C2 Class 2C2 Class 3C2
Organic/biological influences: <ul style="list-style-type: none"> ● Storage (in transport packaging) according to EN 60721-3-1 ● Transport (in transport packaging) according to EN 60721-3-2 ● Operation acc. to EN 60721-3-3 	Class 1B1 Class 2B1 Class 3B1
Degree of pollution according to EN 61800-5-1	2

Standards and Directives	
Standards conformance	UL, CE, c-tick
CE marking	According to Low-Voltage Directive 2006/95/EC
EMC Directive acc. to EN 61800-3 2004 <ul style="list-style-type: none"> ● Frame sizes FSA to FSF with integrated line filter class A ● Frame sizes FSA to FSF with integrated or external line filter class B 	With shielded motor cable up to 25 m: Category C2, corresponds to Class A acc. to EN 55011 Category C1, corresponds to class B acc. to EN 55011 for conducted interference emission
Variable-speed electrical power drive systems – Part 3: EMC product standard including specific test methods	EN 61800-3: 2004
Electromagnetic compatibility – Part 3-12: Limit values for temperature monitoring	EN 61000-3-12: 2011 (RSCE > 250)



UL approval for frame sizes FSD to FSF will be available soon.

Derating factors

Derating table

The rated power based on the rated output current /N. The rated output current/N is based on the duty cycle for low overload (low overload LO).

Rated output at 3 AC 50 Hz 400 V		Rated output current in A for a pulse frequency of						
Kw	HP	4 kHz	6 kHz	8 kHz	10 kHz	12 kHz	14 kHz	16 kHz
0.75	1.0	2.2	1.87	1.54	1.32	1.10	0.99	0.88
1.1	1.5	3.1	2.64	2.17	1.86	1.55	1.40	1.24
1.5	2.0	4.1	3.49	2.87	2.46	2.05	1.85	1.64
2.2	3.0	5.9	5.02	4.13	3.54	2.95	2.66	2.36
3.0	4.0	7.7	6.55	5.39	4.62	3.85	3.47	3.08
4.0	5.0	10.2	8.67	7.14	6.12	5.1	4.59	4.08
5.5	7.5	13.2	11.22	9.24	7.92	6.6	5.94	5.28
7.5	10	18.0	15.3	12.6	10.8	9.0	8.1	7.2
11.0	15	26.0	22.1	18.2	15.6	13.0	11.7	10.4
15.0	20	32.0	27.2	22.4	19.2	16.0	14.4	12.8
18.5	25	38.0	32.3	26.6	22.8	19.0	17.1	15.2
22	30	45.0	38.25	31.5	27.0	22.5	20.25	18.0
30	40	60.0	52.7	43.4	37.2	31.0	27.9	24.8
37	50	75.0	63.75	52.5	45.0	37.5	33.75	30.0
45	60	90.0	76.5	63.0	54.0	45.0	40.5	36.0
55	75	110	93.5	77.0	-	-	-	-
75	100	145	123.3	101.5	-	-	-	-
90	125	178	151.3	124.6				

Derating in relation to the ambient temperature

Low overload (LO) for Power Modules PM230, frame sizes A to F

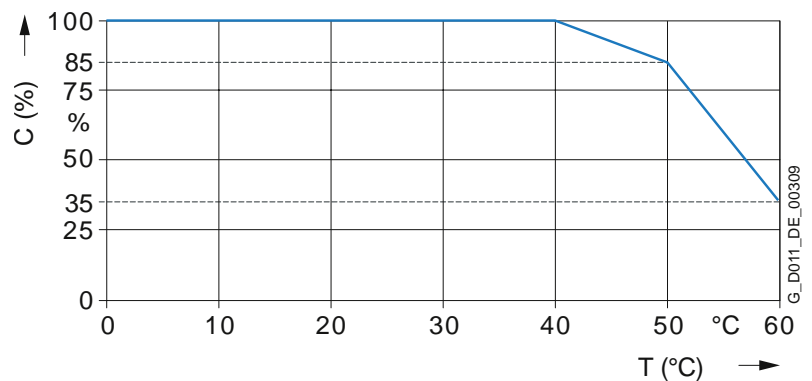

T (°C) = ambient temperature
C (%) = permissible output current

High overload (HO) for Power Modules PM230, frame sizes A to F

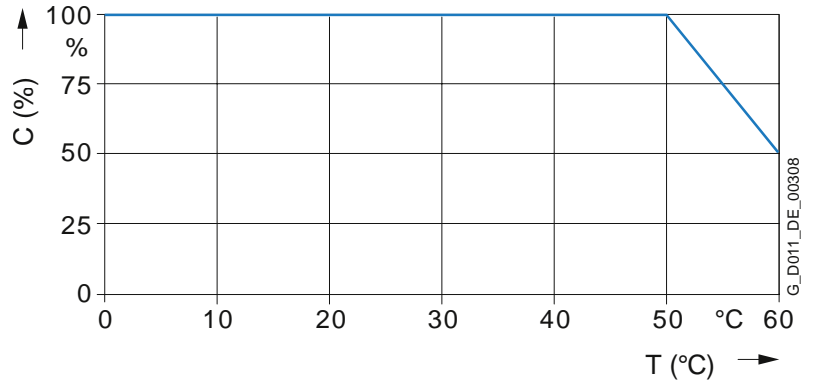

T (°C) = ambient temperature
C (%) = permissible output current

Derating in relation to the air pressure in meters above sea level

Permissible output current in relation to the installation altitude

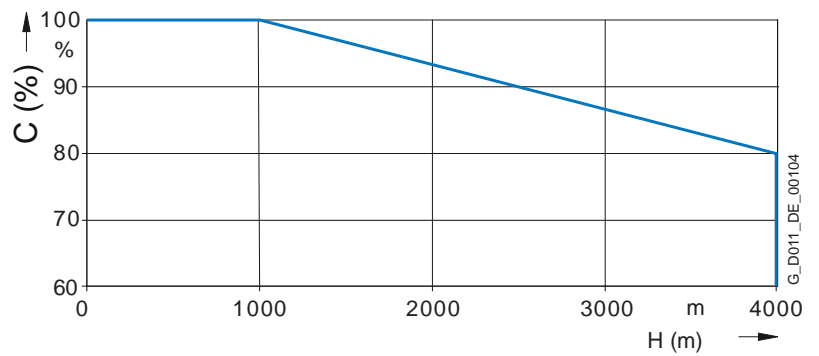

H (m) = installation altitude above sea level
C (%) = permissible output current

Permissible input voltage in relation to the installation altitude

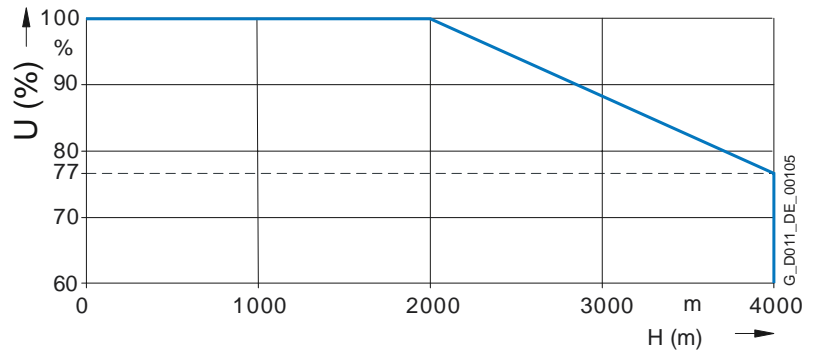

H (m) = installation altitude above sea level
U (%) = permissible input voltage

Derating in relation to the line voltage

Permissible output current in relation to the line voltage

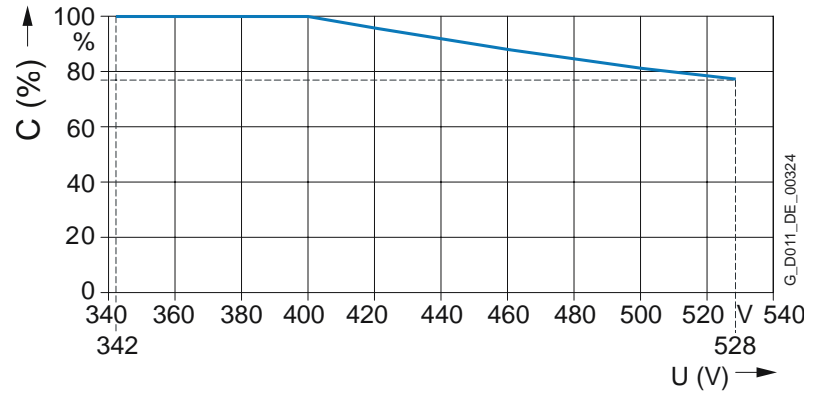

U (V) = line voltage
C (%) = permissible output current

Permissible rated power in relation to the line voltage

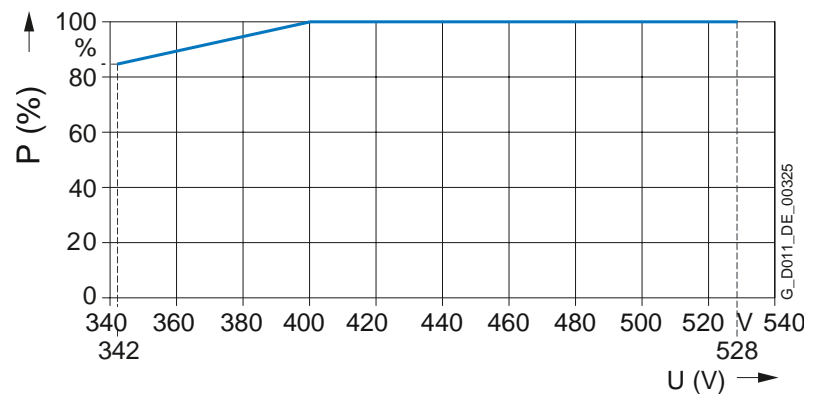

U (V) = line voltage
P (%) = permissible rated power

Connection diagram Control Unit CU230P-2 BT

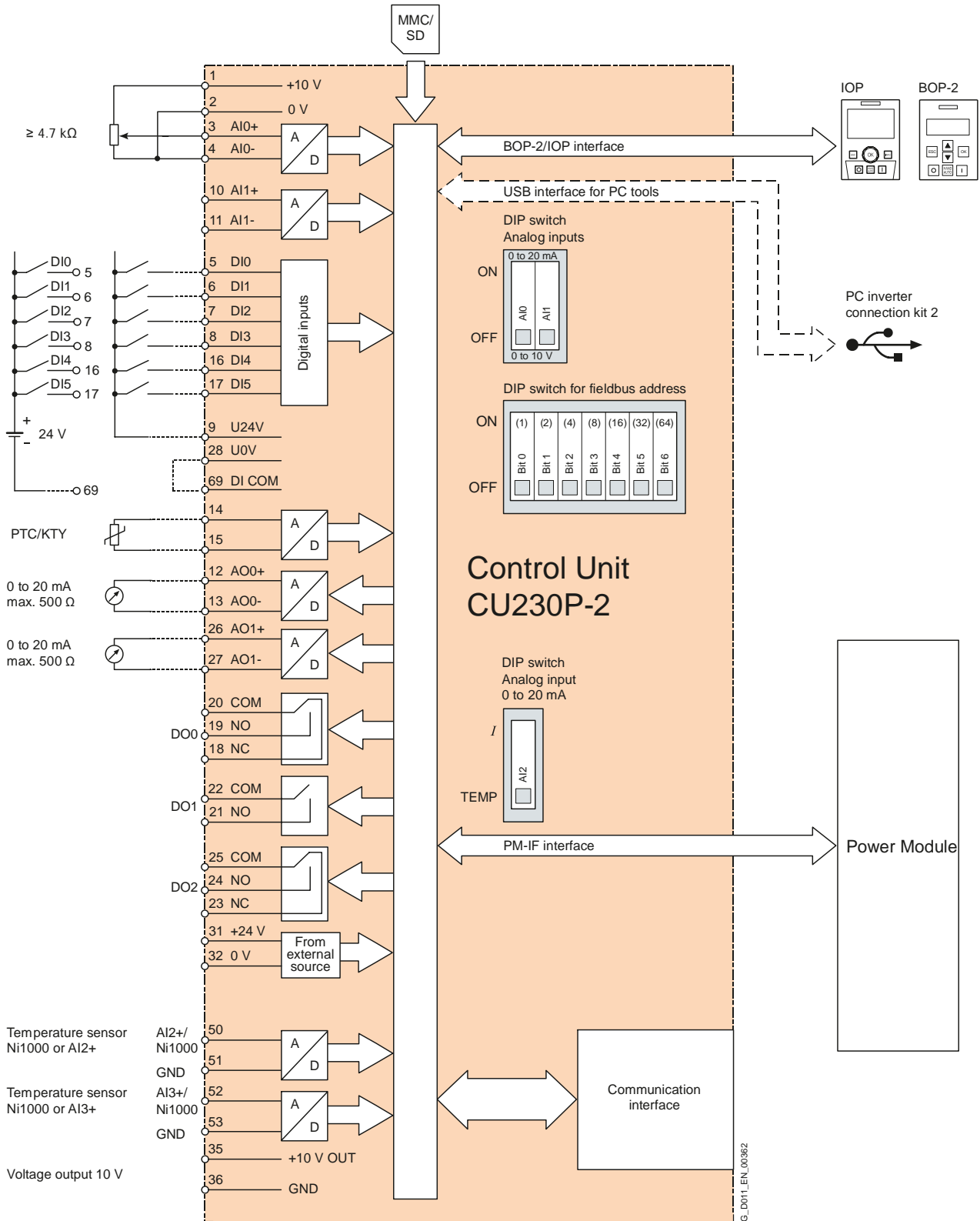

Dimension drawing Power Module PM230, IP55 with integrated line filter A/B

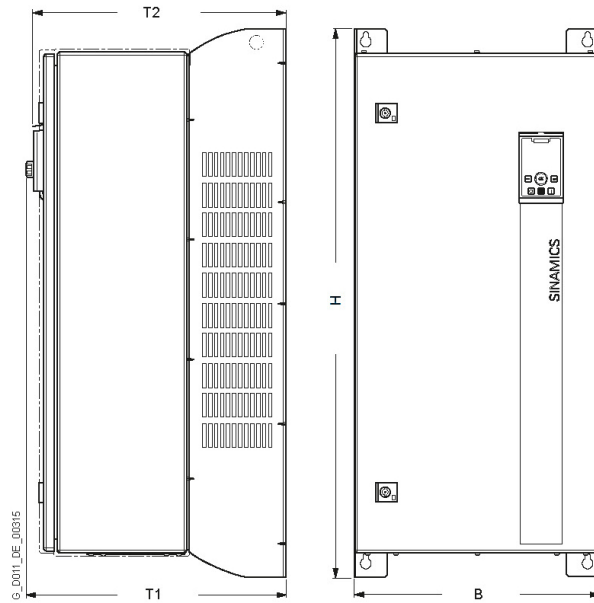

Frame size	Dimensions (mm)					Clearances (mm)		
	B	H	T1 with IOP-2	T1 with blanking cover/ BOP-2	T2 without cover	Waste heat (top)	cooling air (bottom)	cooling air (side)
A	154	460	266	256	249	100	100	0
B	180	540	266	256	249	100	100	0
C	230	620	266	256	249	125	125	0
D	320	640	346	336	329	300	300	50
E	320	751	346	336	329	300	300	50
F	410	915	433	423	416	350	350	50

Dimension drawing PM230 Power Module, IP20

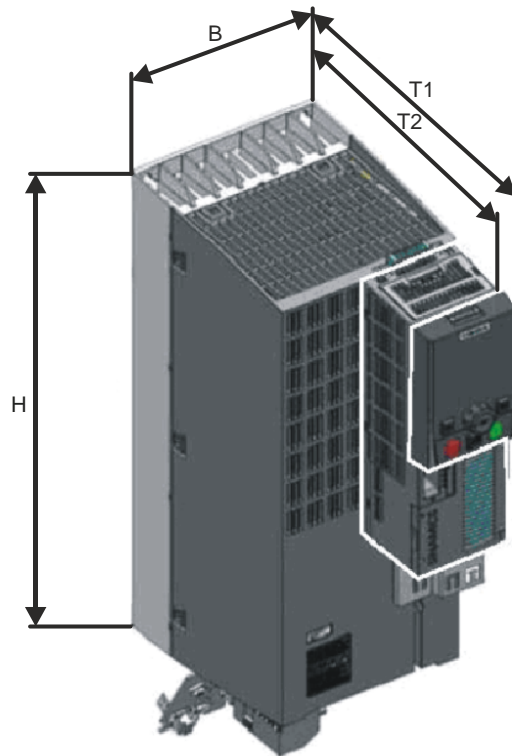

Power Module PM230, IP20 with integrated line filter A							
Frame size	Dimensions (mm)					Clearances (mm) ²⁾	
	H ¹⁾	B	T1 with IOP-2	T1 with blanking cover/ BOP-2	T2 without cover	Waste heat (top)	Cooling air (bottom)
FSA	196	73	245	235	223	80	100
FSB	292	100	245	235	223	80	100
FSC	355	140	245	235	223	80	100
FSD	512	275	275	265	253	300	300
FSE	635	275	275	265	253	300	300
FSF	934	350	387	377	365	350	350

Power Module PM230, IP20 with external filter B							
Frame size	Dimensions (mm)					Clearances (mm) ²⁾	
	H ¹⁾	B	T1 with IOP-2	T1 with blanking cover/ BOP-2	T2 without cover	Waste heat (top)	Cooling air (bottom)
FSA	202	73	310	300	288	80	100
FSB	297	100	330	320	308	80	100
FSC	359	140	340	330	318	80	100
FSD	512	375	275	265	253	300	300
FSE	635	385	275	265	253	300	300
FSF	934	500	387	377	365	350	350

¹⁾ When using a shield connection kit: FSA: + 80 mm; FSB: + 78 mm; FSC: + 77 mm; FSD, FSE, FSF: + 123 mm

²⁾ The Power Modules can be mounted side-by-side. For tolerance reasons, we recommend a lateral clearance of approx. 1 mm.

For the frame sizes FSA FSC, the external filter B is pre-mounted on the back at the factory. The frame sizes FSD FSF have a side filter that has to be mounted separately. The dimensions above represent the total spatial requirements.

Issued by
Siemens Switzerland Ltd
Building Technologies Division
International Headquarters
Gubelstrasse 22
CH-6301 Zug
Tel. +41 41-724 24 24
www.siemens.com/buildingtechnologies

© 2012 Siemens Switzerland Ltd
Technical specifications and availability subject to change without notice.