

Electromotoric actuator

SSA151.05HF, SSA161.05HF, SSA161E.05HF



For pressure independent combi valves (PICV), radiator valves, MiniCombi valves (MCV) and small globe valves

- SSA151.05HF: Operating voltage AC/DC 24 V, positioning signal DC 4...20 mA
- SSA161.05HF, SSA161E.05HF: Operating voltage AC/DC 24 V, positioning signal DC 0...10 V
- Self calibrating to the valve stroke
- Direct mounting with coupling nut, no tools required
- Manually adjustable, position and actuator motion indication (LED)
- Positioning force 100 N
- Parallel operation of multiple actuators possible
- Integral cable length 1.5 m

Use

- For radiator valves, VDN.., VEN.., VUN..
- For Siemens PICV (pressure independent combi valves) VPP46.. and VPI46..
- For MiniCombi valves VPD.., VPE..
- For small valves VD1..CLC
- For radiator valves (M30 × 1.5) from other manufacturers without adapter
- Typically in radiator, chilled ceiling, VAV and fan coil unit applications
- Max.10 units of SSA161.05HF/SSA161E.05HF are able to operate in parallel, provided the controller output suffices.



NOTICE

SSA161E.05HF is only compatible with VPD.., VPE.., VPP46.. and VPI46...

Technical design

When the actuator is driven by DC 0...10 V control voltage or a DC 4...20 mA signal, it produces a stroke, which is transmitted to the valve stem.

The description of operation in this document applies to valve versions that are fully open when valve stem is extended / no actuator is mounted (Normally Open (NO) valve).

Control signal with input impedance 4-20 mA 150Ω (for SSA151.05HF)

- The valve opens / closes in proportion to the control signal at Y.
- At 4 mA, actuator stem extended, the valve is fully closed.
- When no power is supplied, the actuator maintains its current position.
- This actuator provides a 4...20 mA position feedback signal proportional to the stroke of the actuator stem.

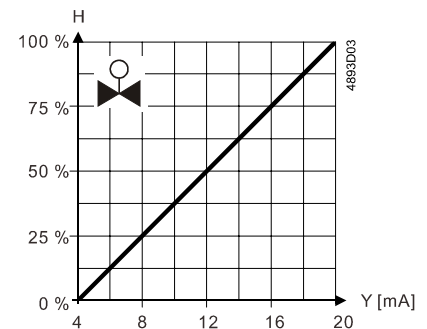

Y = Control signal Y [mA]

H = Percentage of calibrated valve stroke

DC 0...10 V control signal (for SSA161.05HF)

- The valve opens / closes in proportion to the control signal at Y.
- At DC 0 V, actuator stem extended, the valve is fully closed.
- When no power is supplied, the actuator maintains its current position.
- This actuator provides a DC 0...10 V position feedback signal proportional to the stroke of the actuator stem.

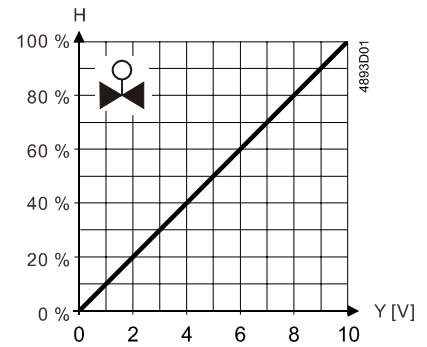

Y = Control signal Y [V]

H = Percentage of calibrated valve stroke

DC 0...10 V control signal (for SSA161E.05HF)

Combi valves VPI46../VPP46.. in combination with SSA161E.05HF have equal-percentage characteristics.

- The valve opens / closes in equal percentage ratio to the control signal at Y.
- At DC 0 V, actuator stem extended, the valve is fully closed.
- When no power is supplied, the actuator maintains its current position.
- This actuator provides a DC 0...10V position feedback signal proportional to the stroke of the actuator stem.

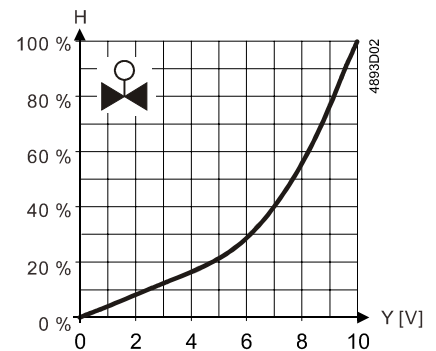

Y = Control signal Y [V]

H = Percentage of calibrated valve stroke

LED indication

Color	Pattern	Flashing interval	Description
Green	Flashing	0.1 s	Self-calibration
		0.5 s	Actuator stem is moving.
	Constant	-	Actuator stem reaches a set position. The LED turns off after it is constantly on for five seconds.
Green/red	Flashing	0.5 s	Manual operation
Red	Constant	-	Error*

* Hint: calibration or power reset required.

Type summary

Type	Stock number	Operating voltage	Running speed	Running time 2.5 mm	Control signal	Actuator characteristic	Cable length
SSA151.05HF	S55180-A110	AC/DC 24 V	10 s/mm	25 s	DC 4...20 mA	Linear	1.5 m
SSA161.05HF	S55180-A108	AC/DC 24 V	10 s/mm	25 s	DC 0...10 V	Linear	1.5 m
SSA161E.05HF	S55180-A109	AC/DC 24 V	10 s/mm	25 s	DC 0...10 V	Equal percentage	1.5 m

Ordering

When ordering, specify both type and quantity.

Example:

Type	Stock number	Designation	Quantity
SSA161.05HF	S55180-A108	Electromotoric actuator	2

Delivery

Valves and actuators are supplied in separate packages. For easier valve assembly, the position of the actuator stem (spindle) is fully retracted.

Equipment combinations

Valves

Combinable valves for SSA151.05HF and SSA161.05HF

Type reference	Valve type	K_{vs} [m ³ /h]	\dot{V} [l/h]	PN class	Data sheet
VDN..., VEN..., VUN..	Radiator valves	0.09...1.41	-	PN 10	N2105, N2106
VPD..., VPE..	MCV radiator valves	-	25...483*		N2185
VD1..CLC	Small valves	0.25...2.60	-		N2103
VPP46..., VPI46..	PICV valves DN10..DN32	-	30...4001	PN 25	N4855
K_{vs} : Nominal flow rate of cold water (5...30 °C) through the fully open valve (H100) by a differential pressure of 100 kPa (1 bar).					
<i>Radiator valves (M30 × 1.5) from other manufacturers, without adapter:</i>					
<ul style="list-style-type: none"> Heimeier 		<ul style="list-style-type: none"> Crane D981.. 		<ul style="list-style-type: none"> TA-Type TBV-C 	
<ul style="list-style-type: none"> Oventrop M30 × 1.5 (from 2001) 		<ul style="list-style-type: none"> MNG 		<ul style="list-style-type: none"> Junkers 	
<ul style="list-style-type: none"> Honeywell-Braukmann 		<ul style="list-style-type: none"> Cazzaniga 		<ul style="list-style-type: none"> Beulco (new) 	

* Nominal volume flow at 0.5 mm stroke.

Combinable valves for SSA161E.05HF

Type reference	Valve type	K_{vs} [m ³ /h]	\dot{V} [l/h]	PN class	Data sheet
VPP46.., VPI46..	PICV valves DN10..DN32	-	30...4001	PN 25	N4855
Kvs: Nominal flow rate of cold water (5...30 °C) through the fully open valve (H100) by a differential pressure of 100 kPa (1 bar).					

Note: To ensure trouble-free operation of third-party valves with the SSA.. actuator, the valves must satisfy the following requirements:

- Threaded connections with coupling nut M30 × 1.5.
- Nominal force $F \leq 100$ N
- Dimension $X \geq 8.3$ mm
- Dimension $Y \leq 14.8$ mm

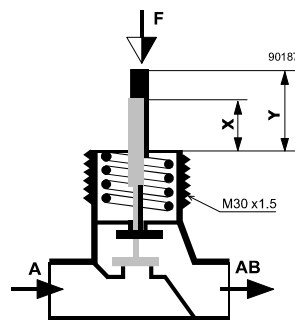

Controllers

Type	SSA151.05HF	SSA161.05HF	SSA161E.05HF
	AC/DC 24 V	AC/DC 24 V	AC/DC 24 V
	DC 4...20 mA	DC 0...10 V	DC 0...10 V
DXR2	-	DXR2..09..	-
RXB..	-	RXB39.1..	-
Synco 700 Synco 200	-	RMU7...0B-1, RMS705B-1, RMH760B-1, RMK770-1, RLU220, RLU222, RLU232, RLU236	-

Combinable room thermostats for SSA161.05HF and SSA161E.05HF

Type	Detail
RDG..	RDG160KN, RDG160T, RDG405KN
RDU..	RDU340
RCU..	RCU50..



NOTICE

SSA151.05HF cannot be used in combination with the above thermostats as its control signal of DC 4...20 mA is not supported by these thermostats.

Product documentation

Topic	Title	Document ID:
Mounting and installation	Mounting instructions ¹⁾	A6V11858272
Standards and directives	CE declarations	A5W00106106A
	RCM conformity	A5W00106107A
Environmental compatibility	Environmental declarations	A5W00109220A

¹⁾ The mounting instructions is enclosed in product packaging.

Related documents such as environmental declarations, CE declarations etc., can be downloaded from <http://siemens.com/bt/download>.

Notes

Engineering

The actuators must be electrically connected in accordance with local regulations (see "Connection diagrams [► 13]").

	⚠ CAUTION
	National safety regulations Failure to comply with national safety regulations may result in personal injury and property damage. <ul style="list-style-type: none">• Observe national provisions and comply with the appropriate safety regulations.

Observe permissible temperatures (see "Technical data [► 11]"). The connecting cable of the actuator may come into contact with the hot valve body, provided the temperature of the valve body does not exceed 80 °C.

Mounting

	⚠ WARNING
	<ul style="list-style-type: none">• Do not use pipe wrenches, spanners or similar tools.• Before mounting, fit the actuator in a position where the actuator stem is fully retracted (see "Manual operation [► 8]").• Avoid lateral pressure or (cable) tension on the mounted actuator!

Valve and actuator are easy to assemble on site before commissioning:

- Remove protective cover from the valve body.
- Position the actuator and tighten the union nut manually.
- See [Mounting instructions](#) enclosed with the product package for graphical instructions.

Orientation

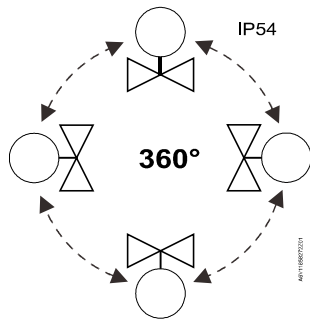

Installation

	A [mm]	B [mm]	C [mm]
	5.5	4.2	50
Crimp ferrule on stripped wire of connecting cable.			

- Observe all admissible temperatures (see “Technical data [▶ 11]”).
- Do not twist the cable.
- Magnets can damage the actuator.
- Provide a means for isolation from the power supply, e.g., connecting a circuit breaker or switch fuse upstream of the control unit.

	⚠ CAUTION
	National safety regulations Failure to comply with national safety regulations may result in personal injury and property damage. <ul style="list-style-type: none"> • Observe national provisions and comply with the appropriate safety regulations.

	⚠ CAUTION
	Phase cut and pulse-duration-modulated (PDM) signals are not suitable. Regulations and requirements to ensure the safety of people and property must be observed at all times!

Commissioning

When commissioning, check both wiring and functioning of the actuator.

- | | |
|--------------------------|--------------|
| • Actuator stem extends | Valve closes |
| • Actuator stem retracts | Valve opens |



NOTICE

The actuator must be commissioned only with a correctly mounted valve in place!

Self-calibration

When operating voltage is applied, the actuator self-calibrates (fully retracted → fully extended → setpoint).

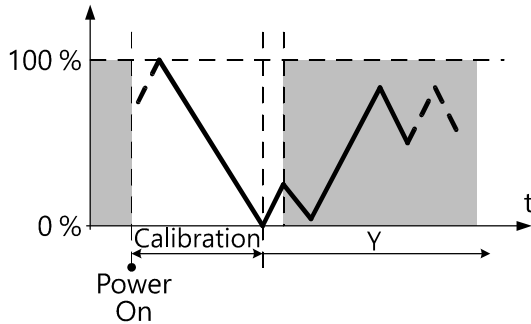

CAUTION

Never intervene manually during self-calibration.



NOTICE

- Correct calibration is only possible with valve stroke > 1.2 mm. Valve stroke < 1.2 mm results calibration failure.
- If calibration fails, the actuator performs another calibration automatically after 10 seconds.
- After three failed calibration attempts, the actuator stem remains in the extended position and the valves are closed.

Manual operation

A 3-mm hexagonal socket wrench can be used to move the actuator to any position.

To move the actuator stem manually

1. Open the cover using a proper screwdriver. Note that IP54 protection does not apply if the cover is open.
2. Press and hold down button (a) illustrated below for at least three seconds.
⇒ The actuator ignores any control signal from the controller.
3. Adjust the position of the actuator stem by rotating hexagon socket (b) illustrated below clockwise or anti-clockwise.
⇒ The actuator stem moves down if you rotate clockwise; it moves up if you rotate anti-clockwise. The manually set position is retained.
4. Press and hold down button (a) illustrated below again for at least three seconds.
⇒ The actuator runs a self-calibration automatically. Control signal sent from the controller takes effect.
5. Close the cover to ensure IP54 protection.

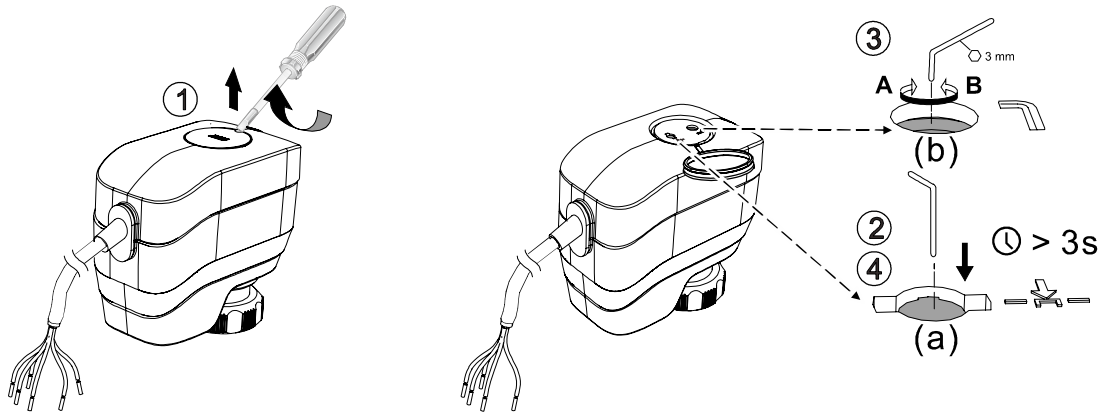

	<p>⚠ WARNING</p>
	<p>If operating voltage is switched on, press button (a) before and after adjusting the position of the actuator stem. If you switched off operating voltage and control signal, you can adjust the position directly without pressing button (a).</p>

Maintenance

The actuators require no maintenance.

	<p>⚠ WARNING</p>
	<p>Operating voltage must be switched off during any maintenance!</p>

	<p>NOTICE</p>
	<p>When carrying out service work on the plant, note the following:</p> <ul style="list-style-type: none"> • Switch off operating voltage. • If necessary, disconnect electrical connections from the terminals. • The actuator must be commissioned only with a correctly mounted valve in place!

Repair

The actuators cannot be repaired; the complete unit must be replaced.

Disposal

	<p>The device is considered an electronic device for disposal in accordance with European guidelines and may not be disposed of as domestic waste.</p> <ul style="list-style-type: none"> • Dispose of the device through channels provided for this purpose. • Comply with all local and currently applicable laws and regulations.
---	--

Warranty

Technical data on specific applications are valid only together with Siemens products listed under "Equipment combinations". Siemens rejects any and all warranties in the event that third-party products are used.

Open Source Software (OSS)

Software license overview

These devices use Open Source Software (OSS). All Open Source Software components used in the product (to include copyrights and licensing agreement) are available at <http://siemens.com/bt/download>.

Firmware version	OSS document		Device
	Document ID	Title	
1.8.0	A6V12067557	Readme OSS "MRA Modulating – 1.1"	SSA161.05HF SSA151.05HF SSA161E.05HF

Power supply		
Operating voltage	AC 24 V (± 15 %) or DC 24 V (± 20 %)	
Frequency	50/60 Hz	
Power consumption	Running	2.5 VA
	Holding	2 VA
Primary fuse or breaker rating	External, 2 A quick blow	

Signal input	SSA151.05HF	SSA161.05HF/SSA161E.05HF
Control signal	4...20 mA	DC 0...10 V
Input impedance	150 Ohm	100 kOhm
Parallel operation (number of actuators)	1	Max. 10 ¹⁾

¹⁾ Provided that the controller output is sufficient.

Signal output	SSA151.05HF	SSA161.05HF/SSA161E.05HF
Feedback signal	4...20 mA	DC 0...10 V
Max. output current	-	1 mA
Max. output voltage	24 V	-
Resolution	1:100	1:100

Operating data	
Position with de-energized contact Y	See "Technical design [▶ 2]"
Running speed	<10 s/mm
Positioning force	100 N
Stroke	1.2...6.5 mm
Permissible temperature of medium in the connected valve	1...110 °C (1...90 °C for MCV-radiator valves)

Electrical connection (connecting cable integral)	
Cable length (integral)	1.5 m, according to VDE 0207
Cross section of prewired connection cables	0.34 mm ² (5 ×)
Permissible length for signal lines	20 m

Mounting	
Fixing on valve	Plastic coupling nut M30 × 1.5
Orientation	360°

Standards	
EU conformity (CE)	A5W00106106A
RCM conformity	A5W00106107A
Housing protection degree	IP 54
Protection class according to EN 60730	III
Environmental compatibility	The product environmental declaration (A5W00109220A) contains data on environmentally compatible product design and assessments (RoHS compliance, materials composition, packaging, environmental benefit, disposal).

Housing color	
Cover/base	RAL 9003, signal white
Coupling nut	RAL 7035, light gray

General ambient conditions			
	Operation EN 60721-3-3	Transport EN 60721-3-2	Storage EN 60721-3-1
Environmental conditions	Class 3K3	Class 2K3	Class 1K3
Temperature	1...50 °C	-25...70 °C	-5...50 °C
Humidity	5...85 % r.h.	<95 % r.h.	5...95 % r.h.

Material	
Cover/base	PC + ABS

Weight	
Weight for all variants	224 g

Connection terminals

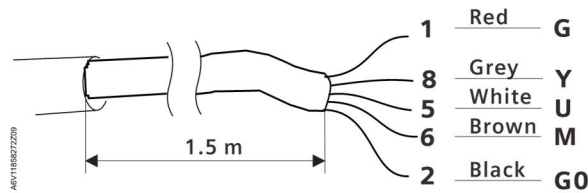

Code	No.	Color	Abbreviation	Meaning	
				SSA151.05HF	SSA161.05HF/ SSA161E.05HF
G	1	Red	RD	System potential AC 24 V (+ DC 24 V)	System potential AC 24 V (+ DC 24 V)
Y	8	Grey	GY	Control signal DC 4...20 mA, < 3 V	Control signal DC 0...10 V, < 0.1 mA
U	5	White	WH	Feedback signal	Feedback signal
M	6	Brown	BR	Measurement reference	Measurement reference
G0	2	Black	BK	System neutral (- DC 24 V)	System neutral (- DC 24 V)

Connection diagrams

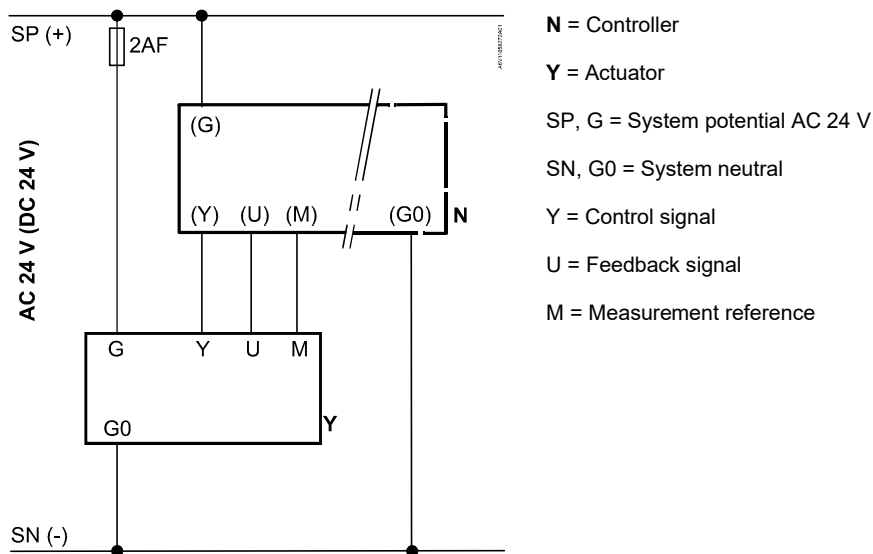

Dimensions

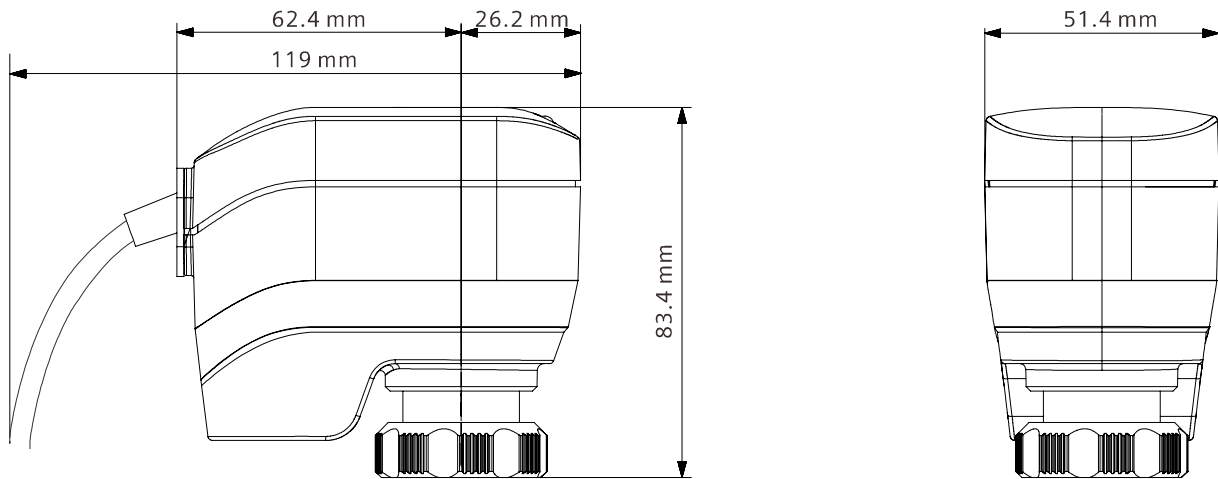

Revision numbers

Type	Valid from rev. no.
SSA151.05HF	..A
SSA161.05HF	..A
SSA161E.05HF	..A

Issued by
Beijing Siemens Cerberus Electronics Ltd.
Smart Infrastructure

No.1, Fengzhi East Road, Xibeiwang
Haidian District, 100094 BEIJING, China
+86 10 64768806
www.siemens.com/buildingtechnologies

© Beijing Siemens Cerberus Electronics Ltd., 2021
Technical specifications and availability subject to change without notice.

Document ID A6V11858278_en--_c
Edition 2021-08-06