

Smart Thermostat

RDS120 Datasheet



Advanced cloud connected thermostat for light commercial and residential applications

- Controls conventional HVAC systems up to 3H/2C and heat pumps up to 4H/2C
- Easy to read, backlit, auto-dimming 3.5" color LCD touch
- Intuitive remote user control using Apple iOS and Android mobile phone applications
- One-touch green leaf button to maximize energy efficiency
- Built-in Volatile Organic Compounds (VOC) sensor enables ventilation strategies for optimum indoor air quality
- Built-in humidity sensor
- Built-in occupancy sensor and window / door contact enables smart occupancy control
- Full, easy to program user schedule

Thermostat Highlights

- Built-in VOC sensor senses wide range of offending organic odors that contribute to stale air and drives ventilation control
- Easy to understand tri-level air quality indication: “Good”, “Okay”, “Poor”
- Built-in temperature and humidity sensors
- Inputs for remote or averaging temperature and humidity sensors
- One-touch operation for “Away”, “OFF”, “FAN” and “Heating/Cooling”
- Configurable setpoint limits
- Password protected screen lock
- Presence detection using a built-in sensor
- PID algorithm for precise control
- Advanced energy saving control with free cooling capability
- Two multifunctional inputs, optional and configurable for:
 - Room temperature
 - Operating mode switch
 - Window / door contact
 - Outside air temperature
 - Room air humidity
 - Presence detector
 - Condensation monitor
 - Room air quality
- Six relay outputs for:
 - Conventional systems up to 3H/2C
 - Heat pumps with up to 2 compressors and 2 stages of auxiliary heat
 - Humidity or ventilation control
- Guided Setup Wizard
- Over the air (OTA) firmware upgradable
- Green Leaf button engages occupants in maximizing system efficiency. If scheduled setpoint is overridden, the green leaf will turn red. One touch will return the system to the programmed setpoint and the leaf will return to green.

Mobile App Features

- Support iOS and Android smartphones
- Support “Dark” and “Light” background colors on mobile app
- Full 7-day programmable schedule with three modes:
 - “Comfort”: comfort settings during occupied periods
 - “Economy”: setting for transition between “Unoccupied” and “Comfort”
 - “Unoccupied”: setting for periods during absence to maximize energy savings
- Duplicates thermostat HMI on smartphone screen
- User account management
- Monitor temperature and humidity
- Monitor indoor air quality: “Good”, “Okay”, “Poor”
- Data security with Siemens Cloud Computing Platform

Application

The RDS120 is designed to control Heat Pump or Conventional HVAC heating and cooling applications. It can control up to three stages of heating and two stages of cooling in conventional systems and up to two compressors and two stages of auxiliary heat in heat pump systems.

The room thermostat consists of the following parts:

- Front housing with touch screen and sensors
- Back housing with terminals and relays
- Mounting hardware for installation on 2"×4" electrical box or directly on drywall

Operation and Settings

Active Display

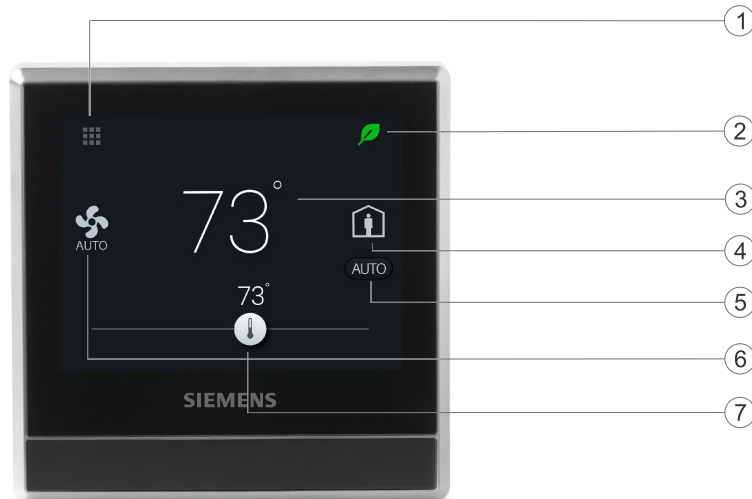

- 1 System setup screens and detailed information display
- 2 Shows if the system is working in an energy-optimized mode. If the leaf is red, some predefined settings have been changed. One touch to the leaf returns settings to configured settings and reverts leaf color to green.
- 3 Room temperature
- 4 Manually select between “At home” and “Away”
- 5 Shows if the thermostat is operating per the schedule (📅) or manually (🔴). Please note:
 - If there is Cloud connection and the scheduler has been programmed, the thermostat will follow it. Any temporary change of the temperature setpoint is effective only during the currently scheduled mode.
 - If there is Cloud connection, but the schedule has not been programmed, the thermostat follows the default schedule.
 - If there is no Cloud connection, the thermostat will have no schedule and will be operated manually.
- 6 Fan mode (AUTO/ON)
- 7 Temperature setpoint slider. Icon color changes as setpoint is changed:
 - Slider changes to red when heating relay is energized.
 - Slider changes to blue when cooling relay is energized.
 - If system has reached setpoint and is idle, the slider color stays white.

Idle Display



- 1 Relative humidity
- 2 Shows room air quality:
 - Green = Very Good
 - Orange = Fair
 - Red = Poor
- 3 Shows if the system is working in an energy-optimized mode. If the leaf is red, some pre-defined settings have been changed. One touch to the leaf returns settings to configured settings and reverts leaf color to green.
- 4 Room temperature

NOTE: Idle mode display will vary based on system configuration.

Ordering Information

Model Number	Orderable Part Number	Description
RDS120	S55772-T101	Room Thermostat

Contents

Items	Quantity
Thermostat (front and rear)	1
Metal mounting plates (small & large)	2
Plastic frame	1
Set of screws and drywall anchors	1
Quick guide	1
Mounting instructions	1
Wiring decals	1
Activation code decal	1

Associated Equipment

Remote sensors

Sensor Type	Model Number	1k Ohm at 32 °F Ni R	1k Ohm Pt RTD	Type 2 Thermistor	0-10 Vdc	Datasheet*
Room Temperature Sensors						
- Wall-mount	QAA2220.EWSN	x				149-714
	QAA2212.EWSN		x			149-714
	QAA2230.EWSN			x		149-714
	QAA22SS.EWSN				x	149-714
- Flush-mount ¹⁾	540-984 (Metal)			x		149-956
	536-994A (Beige)			x		149-956
	536-994B (White)			x		149-956
- Duct-mount	QAM2030.010 (4")			x		149-915
Outdoor Temperature Sensors						
	QAC22	x				149-920
	QAC2012		x			149-920
	QAC2030			x		149-920
	QAC3161				x	149-920
Cable Temperature Sensors						
	QAP22	x				149-918
	QAP2012.150		x			149-918
	QAP1030.200			x		149-918
Room Humidity Sensors						
- Wall-mount including temperature	QFA3212.EWSN		x(T)		x (r.h.)	149-714
	QFA32SS.EWSN				x (T+r.h.)	149-714
- Duct-mount including temperature	QFM2160U				x (T+r.h.)	149-991
Indoor Air Quality Sensors						
- CO ₂	QPA2000				x	149-910
- VOC + CO ₂	QPA2002				x	149-910
	QPA2002D ¹⁾				x	149-910
- CO ₂ including temperature	QPA2060				x(CO ₂ +T)	149-910
	QPA2060D ¹⁾				x(CO ₂ +T)	149-910

Sensor Type	Model Number	1k Ohm at 32 °F Ni R	1k Ohm Pt RTD	Type 2 Thermistor	0-10 Vdc	Datasheet*
- Duct-mount CO ₂	QPM2100				x	149-909
- Duct-mount VOC + CO ₂	QPM2102				x	149-909
- Duct-mount CO ₂ including temperature	QPM2160				x(CO ₂ +T)	149-909

* The documents can be downloaded from [Siemens US Download Center](#) by specifying the product number as shown in the above table.

1) With digital display

Replacement Part

Description	Model Number	Orderable Part Number
Plastic trim plate and metal mounting plate for 2" × 4" box (1 set)	ARG100.01	S55772-T102



Product Documentation

Topic	Title	Document number
Mounting and installation	Installation guide	A5W90001425
Installation and operation	User guide	A6V10733807
Startup wizard	Quick guide	A6V11228376
Commissioning	Commissioning guide	A6V11214854
Submittal sheet		A6V11419719
CE declaration		A5W90002476
RCM declaration		A5W90002477
Product environmental declaration		A5W90003412

Notes

Security



⚠ CAUTION

National safety regulations

Failure to comply with applicable safety regulations may result in personal injury and property damage

- Observe and comply with the appropriate safety regulations.

Engineering

See Product Documentation [→ 6] for information on engineering, selection and sizing connecting cables for supply voltage and field devices.

Installation Location

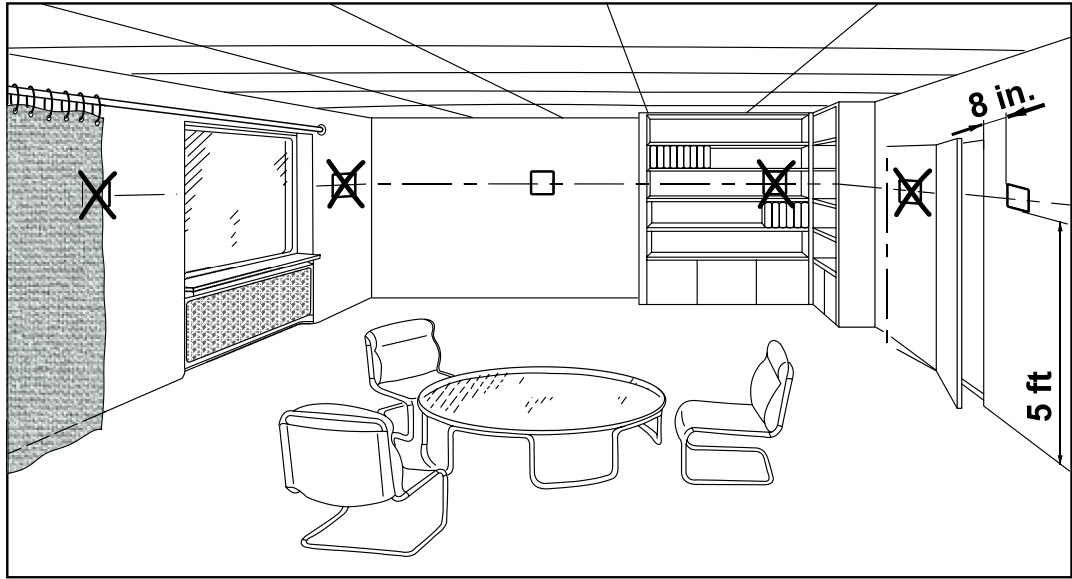

- The devices are suitable for wall installation.
- Recommended height: 5 feet above the floor.
- Do not install the devices in recesses, shelves, behind curtains or doors, or above or near heat sources.
- Avoid direct exposure to sun and drafts.
- Seal the conduit or backwall as drafts can affect sensor readings.
- Observe maximum ambient conditions.

Wiring

Use only class 2 rated power source with proper current limiting.

Installation

Thermostat may be mounted directly on wall using drywall anchors and screws (included). For installation on a 2" x 4" conduit box, use the appropriate mounting plate and plastic trim piece (included).

	⚠ WARNING
	No user serviceable parts inside. Risk of fire and injury due to short-circuits <ul style="list-style-type: none">• Use properly sized wires for connections

Commissioning

Refer to the Quick guide and User guide (see Product Documentation [→ 6]) to configure your device. Commissioning includes the following:

- Internet connection
- Application setup
- Account registration and device pairing

NOTE: Before configuring your thermostat, make sure you have Internet connection, a valid email address, and a smartphone.

Operation

Operating System

OS	OS version	App Store
iOS	iOS 10 or above	App store®
Android	Android™ 5.0 or above	Google Play™

Maintenance

The thermostat is designed for maintenance-free operation.

Disposal



The device is considered an electronic device for disposal in accordance with the European Guidelines and may not be disposed of as domestic garbage.

- Dispose of the device through channels provided for this purpose.
- Comply with all local and currently applicable laws and regulations.

Regulatory information

Radio equipment directive

The equipment is using harmonized frequency in Europe, and also compliances with the Radio Equipment Directive (2014/53/EU, formerly 1999/5/EC).

ISED Regulations (Canada)

This device complies with Industry Canada license-exempt RSS standard(s).

Operation is subject to the following two conditions: (1) this device may not cause interference,

and (2) this device must accept any interference, including interference that may cause undesired operation of the device.

Le present appareil est conforme aux CNR d'Industrie Canada applicables aux appareils radio

exempts de licence. L'exploitation est autorisee aux deux conditions suivantes : (1) l'appareil ne

doit pas produire de brouillage, et (2) l'utilisateur de l'appareil doit accepter tout brouillage radioelectrique subi, meme si le brouillage est susceptible d'en compromettre le fonctionnement.

	⚠ WARNING
Modification of this device to receive cellular radio telephone service signals is prohibited under FCC rules and federal law.	
<p>This equipment has been tested and found to comply with the limits for a Class B digital device, pursuant to part 15 of the FCC Rules. These limits are designed to provide reasonable protection against harmful interference in a residential installation. This equipment generates, uses and can radiate radio frequency energy and, if not installed and used in accordance with the instructions, may cause harmful interference to radio communications. However, there is no guarantee that interference will not occur in a particular installation. If this equipment does cause harmful interference to radio or television reception, which can be determined by turning the equipment off and on, the user is encouraged to try to correct the interference by one or more of the following measures:</p>	
<p>Reorient or relocate the receiving antenna.</p>	
<p>Increase the separation between the equipment and receiver.</p>	
<p>Connect the equipment into an outlet on a circuit different from that to which the receiver is connected. Consult the dealer or an experienced radio/TV technician for help.</p>	
<p>This equipment complies with FCC radiation exposure limits set forth for an uncontrolled environment. This equipment should be installed and operated with minimum distance of 20cm between the radiator & your body.</p>	
<p>Changes or modifications not expressly approved by the party responsible for compliance could void the user's authority to operate the equipment.</p>	

Statement

This device complies with part 15 of the FCC Rules. Operation is subject to the following two conditions: (1) This device may not cause harmful interference, and (2) this device must accept any interference received, including interference that may cause undesired operation.

Power Supply

Power Supply	
Operating voltage	AC 24 V (±20%)
Frequency	48 to 63 Hz
Power consumption	Max. 9 VA
Max. power supply current	4 A current limited

Radio Data

Radio Parameter	
Frequency band	2.4 to 2.4835 GHz
Maximum radio-frequency power	18 dBm
WLAN standard	IEEE 802.11b/g/n (HT20)
WLAN channel	1-11

Inputs

Connections to Multifunctional Inputs X1 - M - X2	
Passive temperature sensors - Cable length max. (copper cable section) - NTC type Room temperature range Outdoor temperature range - Ni type Room temperature range Outdoor temperature range - Pt type Room temperature range Outdoor temperature range	300 ft (90 m) (16 AWG wire), 230 ft (70 m) (18 AWG wire) 200 ft (60 m) (18 AWG wire), 130 ft (40 m) (20 AWG wire) NTC10K Type 2 Thermistor 32 to 122 °F (0...50 °C) -32 to 176 °F (-50...80 °C) Ni1000 at 32 °F (0 °C) RTD 32 to 122 °F (0...50 °C) -32 to 176 °F (-50...80 °C) Pt1000_375/Pt1000_385 at 32 °F (0 °C) RTD 32 to 122 °F (0...50 °C) -32 to 176 °F (-50...80 °C)
Active DC 0 V to 10 V sensors - Room temperature range (default) - Outdoor temperature range (default) - Humidity range (default) - CO ₂ range (default)	Note: min./max. configurable via parameters 32 to 122 °F (0...50 °C) -32 to 176 °F (-50...80 °C) 0 to 100% 0 to 2000 ppm
Digital contacts - Operating action	Selectable N.O./N.C.

Connections to Multifunctional Inputs X1 - M - X2	
- Contact sensing	DC 14 to 40 V, 8 mA (typical)
- Parallel connection	Max. 20 thermostats per switch
- Input function	Selectable

Outputs

Relay Contact Capacity	
Voltage	AC 24 V (±20%)
Current	Min. 0.02 A, Max. 1 A per output

Operational Data

Setpoint Range
45 to 95 °F (7...35 °C)

Built-in Room Temperature Sensor		
Temperature range	Accuracy at 77 °F (25 °C)	Display resolution
32 to 122 °F	±0.9 °F or 0.5 °C	1 °F (0.5 °C)

Built-in Room Humidity Sensor		
Humidity range	Accuracy at 77 °F (25 °C)	Display resolution
0% to 100%	± 5% r.h.	1%

System Compatibility

System Compatibility	
Conventional	2 stages cooling, 3 stages heating
Heat pump	2 stages cooling and 2 stages heating (+2 stages auxiliary heating)

Connections

Interfaces	
Micro USB	A service port is provided for firmware upgrade and on-site diagnosis

Wiring Connections	
Screw terminals	Solid wires or prepared stranded wires: Max. 1 x16 to 20 AWG

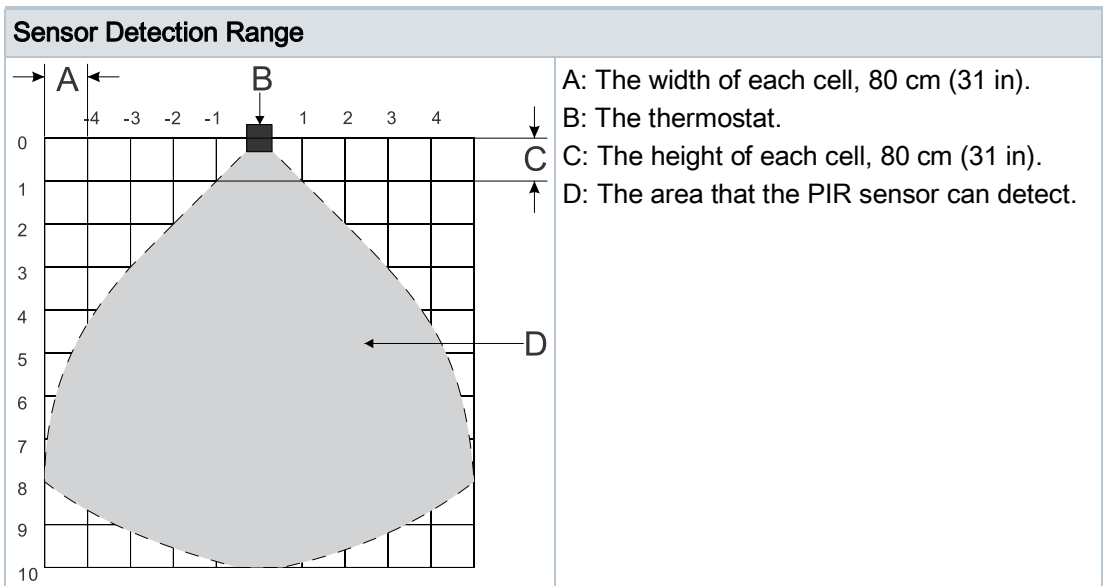

Conformity

Ambient Conditions and Protection Classification	
Safety class according to EN60730	Class III
Degree of protection of housing as per EN 60529	IP30 (NEMA 1)
Classification as per EN 60730	
Function of automatic control devices	Type 1
Degree of contamination	2
Overtoltage category	III
Climatic ambient conditions	
Storage as per EN 60721-3-1	Class 1K3 Temperature -13 to 149 °F (-25 to 65 °C) Humidity 5 to 95%
Transport (packaged for transport) as per EN 60721-3-2	Class 2K3 Temperature -13 to 149 °F (-25 to 65 °C) Humidity 5 to 95%
Operation as per EN 60721-3-3	Class 3K5 Temperature 23 to 122 °F (-5 to 50 °C) Humidity 5 to 95%
Mechanical ambient conditions	
Storage as per EN 60721-3-1	Class 1M2
Transport as per EN 60721-3-2	Class 2M2
Operation as per EN 60721-3-3	Class 3M2

Standards, Directives and Approvals	
EU conformity (CE)	A5W90002476*)
RCM conformity	A5W90002477*)

Standards, Directives and Approvals	
FCC standards	FCC CFR 47 Part 15 Class C
IC standards	RSS-247 issue 1 May 2015, RSS-GEN issue 4 November 2014
UL	UL916
The United Arab Emirates	Authorization Number of TRA: ER54733/17 <div style="border: 1px solid black; padding: 5px; display: inline-block; margin-left: 20px;"> TRA REGISTERED No: ER54733/17 DEALER No: DA64762/17 </div>
Environmental compatibility	The product environmental declaration A5W90003412*) contains data on environmentally compatible product design and assessments (RoHS compliance, materials composition, packaging, environmental benefit, disposal).

*) The documents can be downloaded from <http://siemens.com/bt/download>.

General Data

General		
Dimension	H 3.58" x W 3.58" x D 1.02"	
Weight	Thermostat with package, user document and accessory	15.3 oz (435 g)
	Thermostat	9.5 oz (268 g)
Color	Silver plating Housing: Pantone black	

Diagrams

Connection Terminals

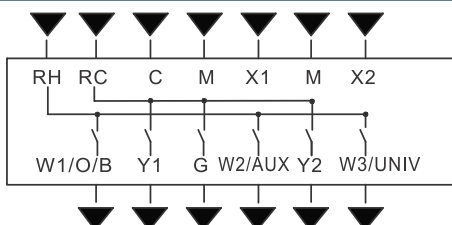

Terminal	Use
RH	AC 24 V, heating system
RC	AC 24 V, cooling system
C	AC 24 V, common
W1/O/B	Stage 1 heating (W1) in conventional system or reversing valve O/B in heat pump system
W2/AUX	Stage 2 heating in conventional system, Stage 1 Aux Heat in heat pump system
W3/UNIV	Stage 3 heating or universal output in conventional system, or Stage 2 auxiliary heat or universal output in heat pump system
Y1, Y2	Stages 1 and 2 cooling in conventional system or Stages 1 and 2 compressor in heat pump system

Terminal	Use
G	Fan
X1, X2	Configurable input
M	Common for X1/X2 inputs

Wiring Diagrams

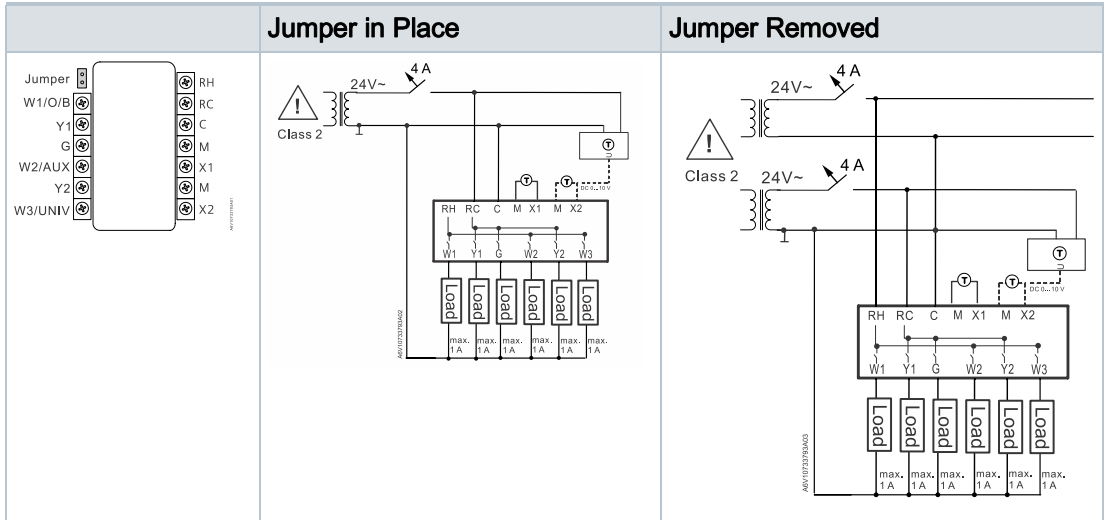

Note:

- For US installations use Class 2 rated power source. For other installations, use current protection with current rated at max. 4 A.
- If a single transformer is used, keep jumper RH-RC in place. Connect AC 24 V to the RC terminal, and neutral to terminal C. If separate transformers are used for heating and cooling systems, remove jumper RH-RC. Connect cooling AC 24 V to terminal RC, neutral to terminal C and heating AC 24 V to terminal RH.

Dimensions

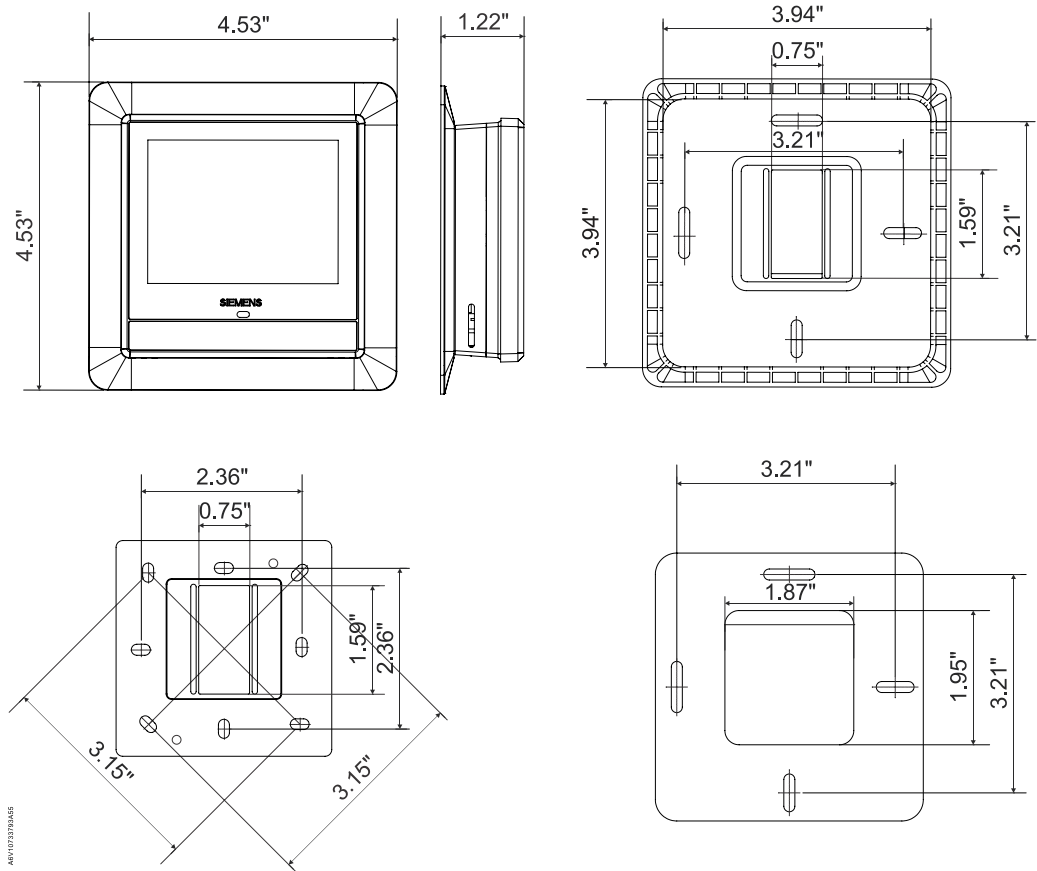

Revision history

Edition	Date	Software version	Changes	Section	Pages
2	November 2018	32.2.28	---	---	---
1	April 2018	32.2.16	New document	---	---

Issued by
Siemens Industry, Inc.
Building Technologies Division
1000 Deerfield Pkwy
Buffalo Grove IL 60089
Tel. +1 847-215-1000

© Siemens Industry, Inc., 2018
Technical specifications and availability subject to change without notice.